

Can you solve these balancing problems?

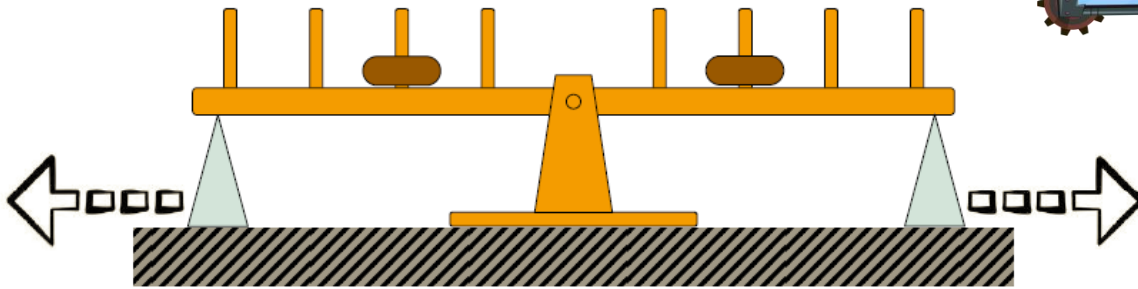

1



What will happen? Circle one.

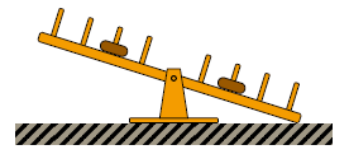
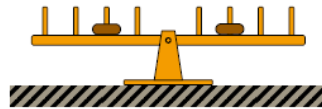
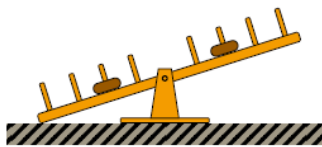

2

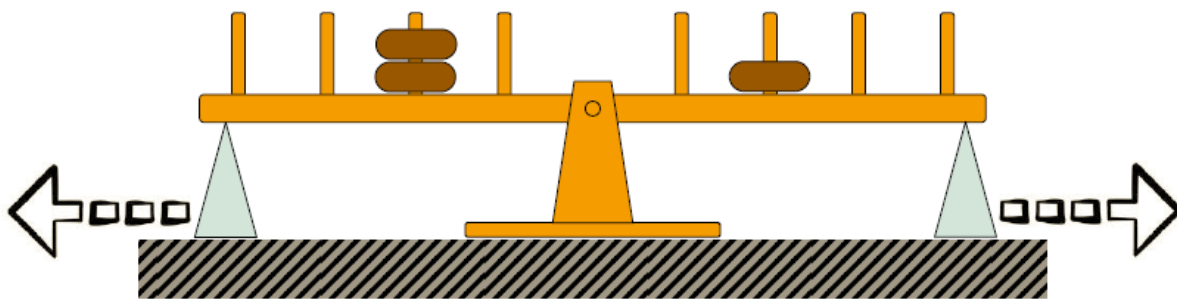

What will happen? Circle One.

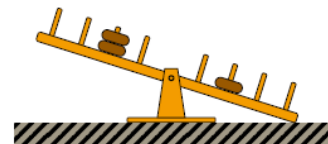
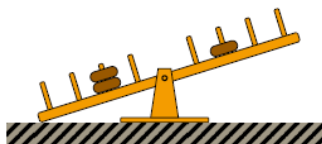

3

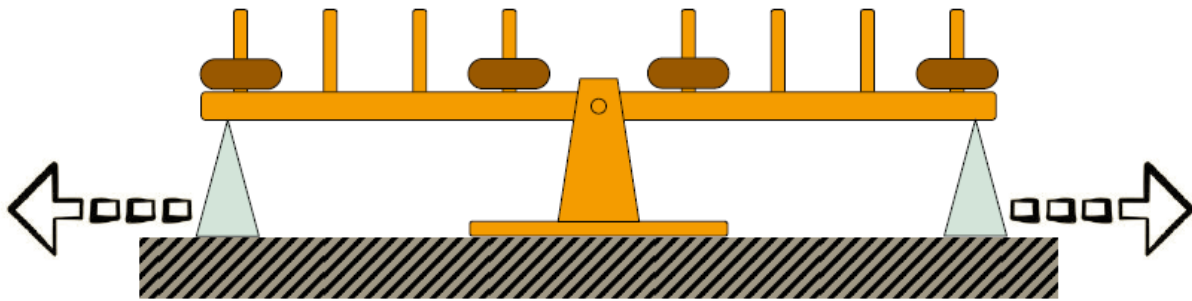

What will happen? Circle one.

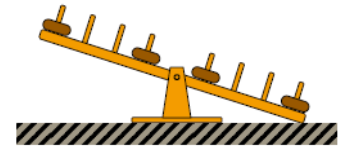
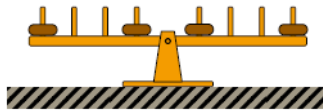
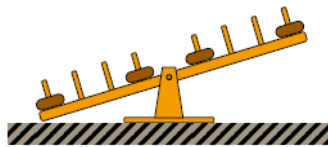

4

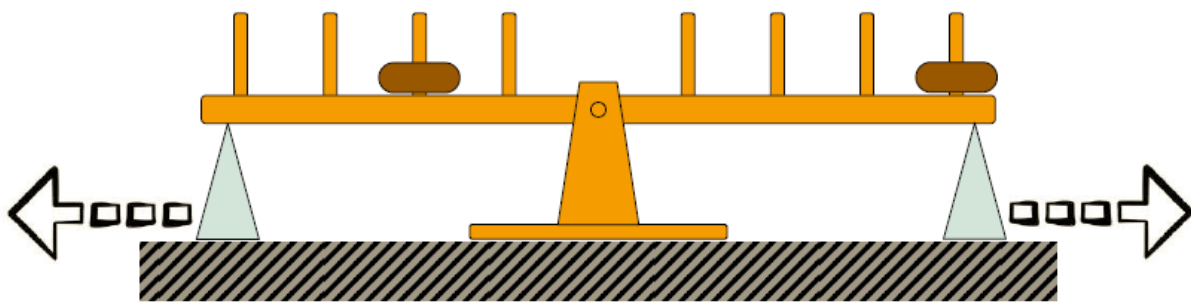

What will happen? Circle one.

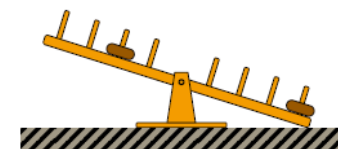
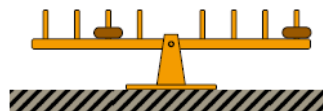
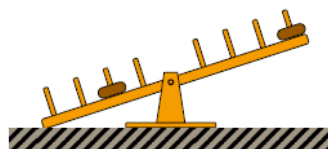

5

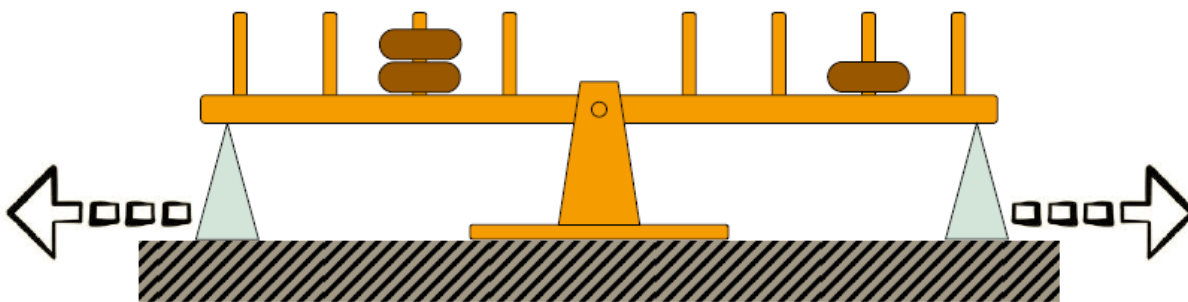

What will happen? Circle one.

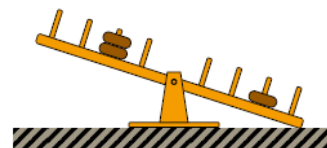
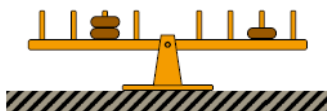
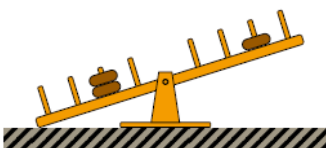

6

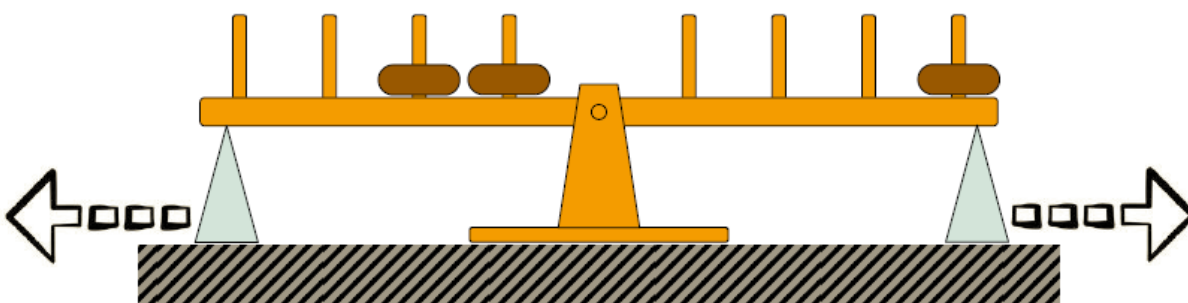

What will happen? Circle one.

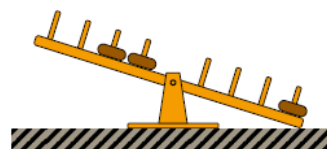
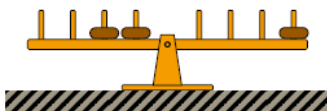
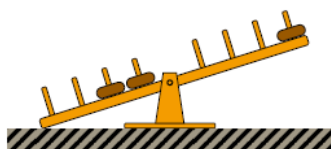

7

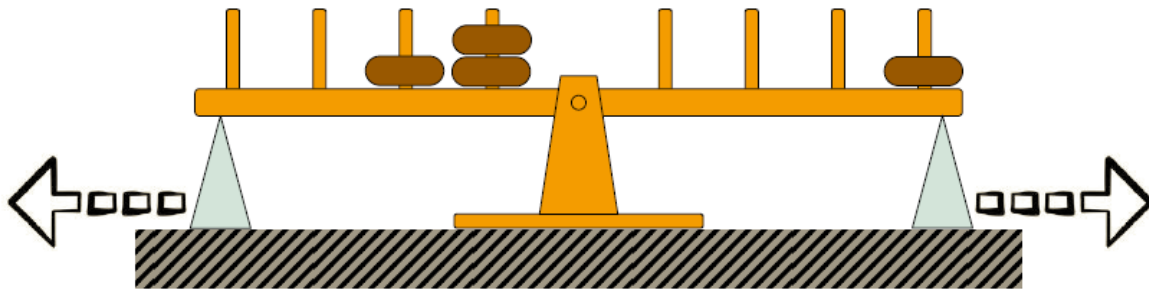

What will happen? Circle one.

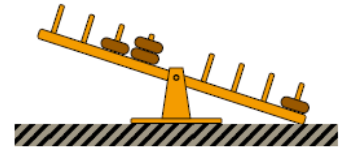
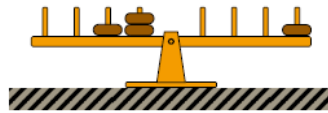
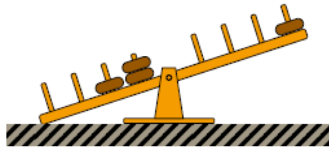

8

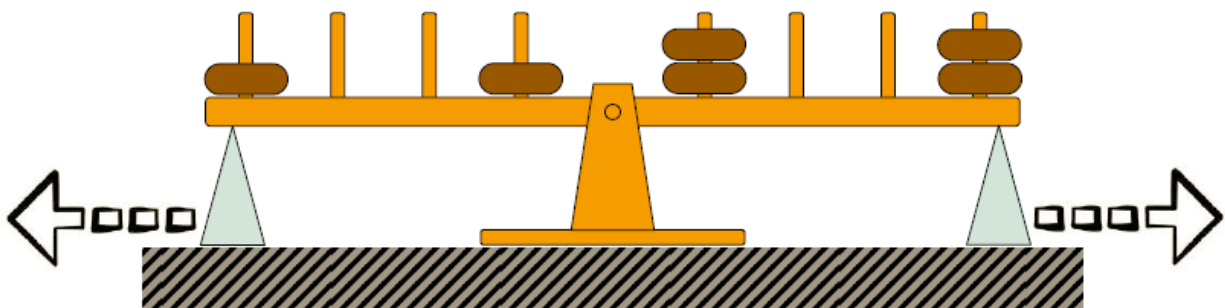

What will happen? Circle one.

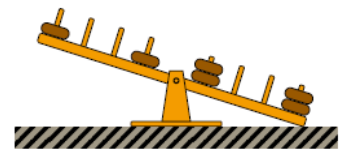
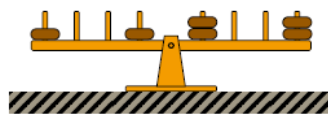
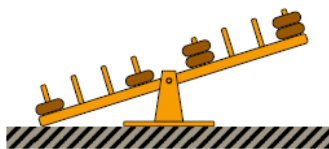

9

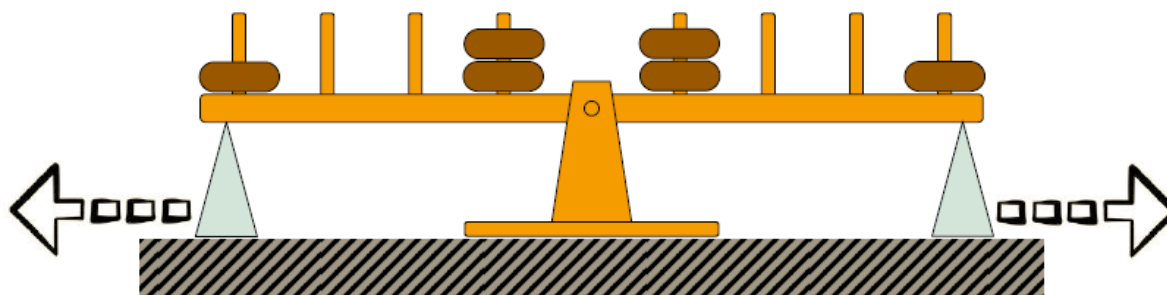

What will happen? Circle one.

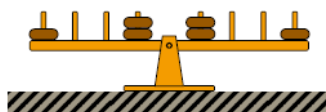
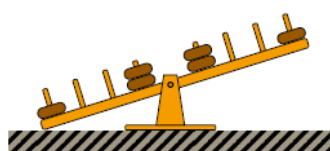

10

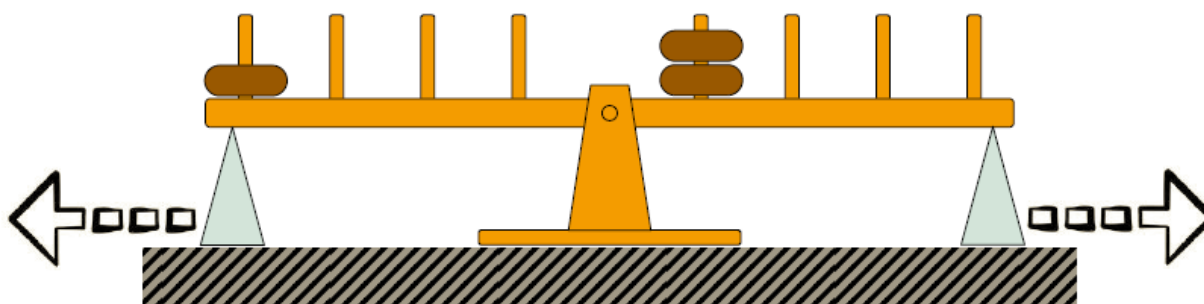

What will happen? Circle one.

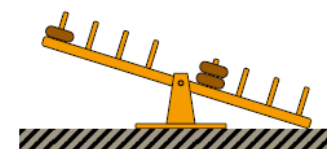
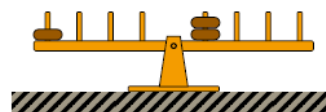

11

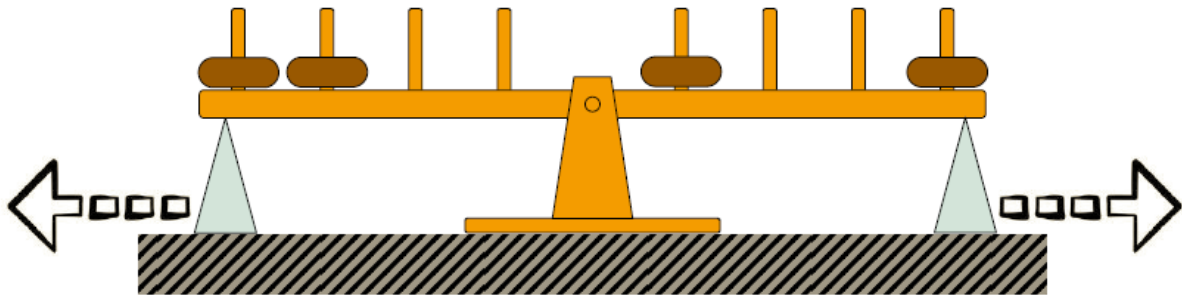

What will happen? Circle One.

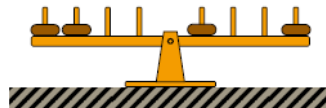
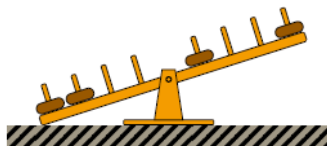

12

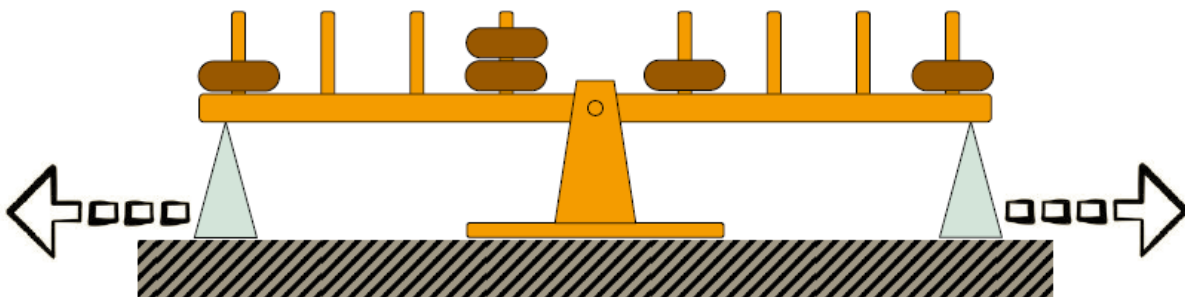

What will happen? Circle one.

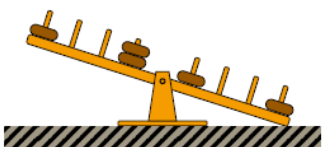
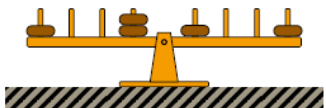
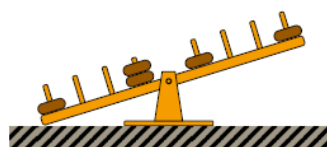

13

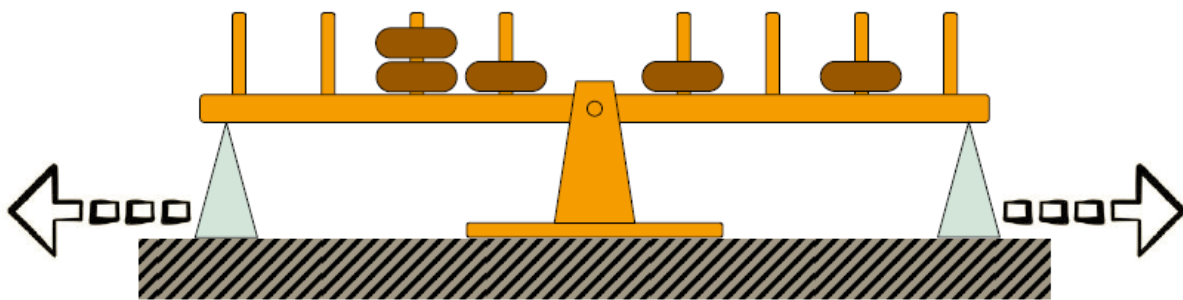

What will happen? Circle one.

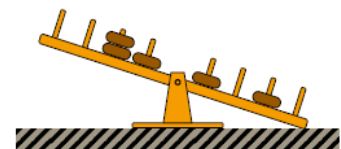
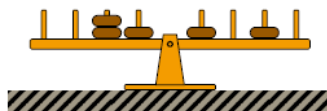
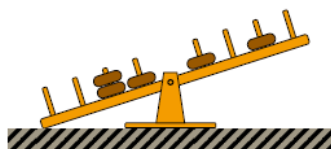

14

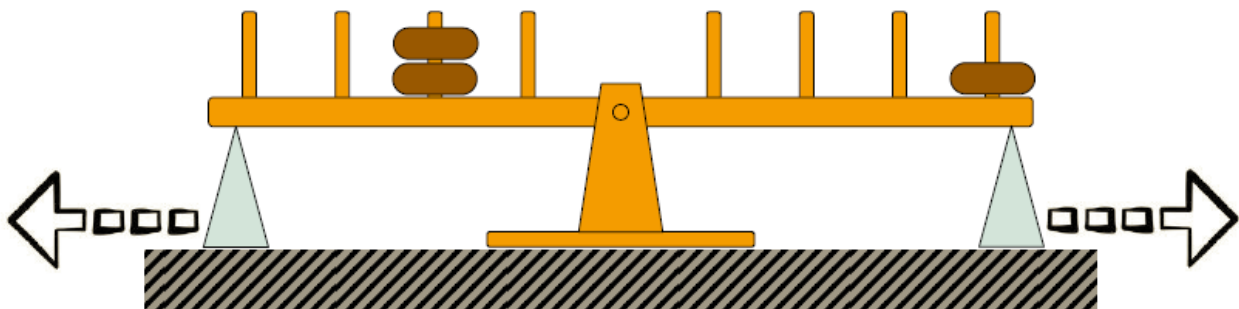

What will happen? Circle one.

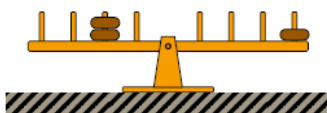
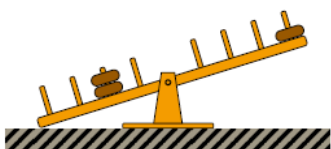

15

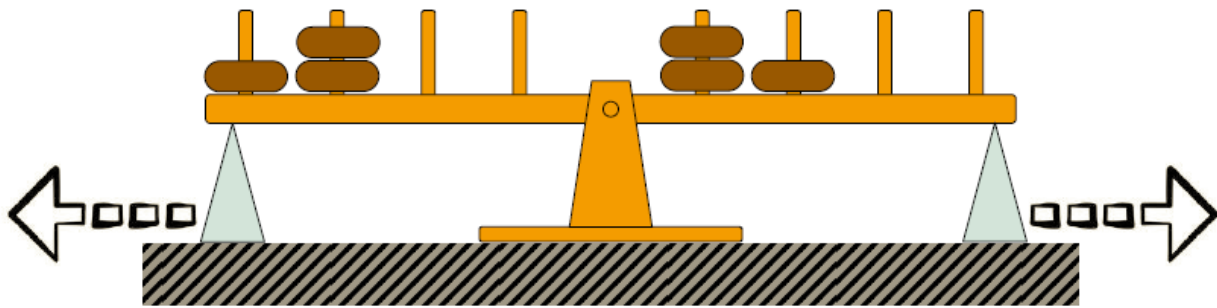

What will happen? Circle one.

